TABLE OF CONTENTS

Subject	Page
IHKA E46 Climate Control	2
Control Panel	5
IHKA E46 I.P.O	6
Fresh Air Microfilter	7
Air Intake	8
Blower Control	9
Stepper Motor M-Bus Control	11
Temperature Regulation	12
Temperature Mixing	13
Temperature Regulation Cooling	14
Compressor Control	15
Auxiliary Fan Control	16
System Operation	18
IHKA Personalization	19

IHKA E46 CLIMATE CONTROL

The IHKA heater/air conditioner in the E46 is very similar to E36. Design and component changes were made to improve the overall performance and operation of the system.

Features of the E46 IHKA system include:

- New Control Panel/Module
- Single heater core for temperature regulation
- M-Bus Control of all stepper motors
- New fresh air micro filter
- Regulated A/C compressor
- Regulated auxiliary fan operation

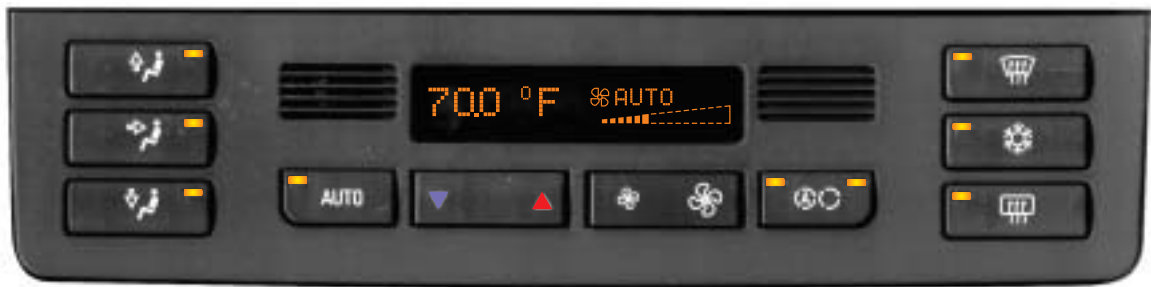
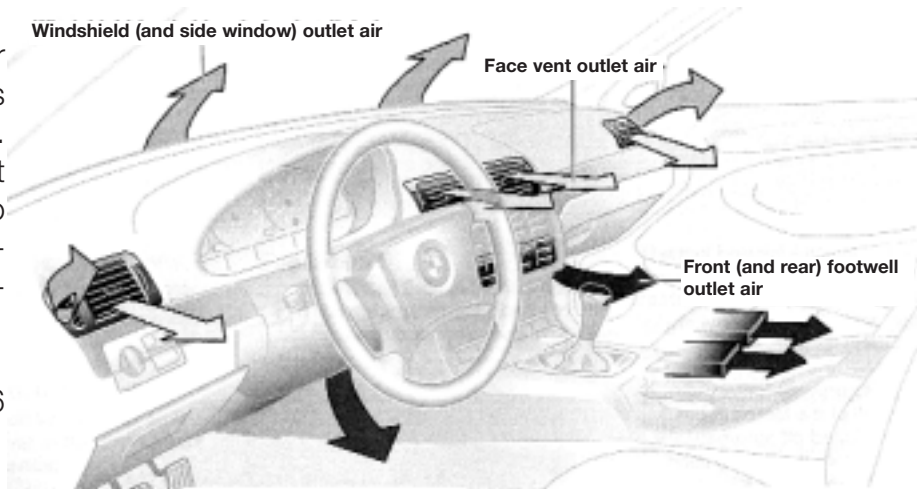

CONTROL PANEL



If the “up arrow” button is pressed, air flows from the windshield defroster outlets.



Pressing the “left arrow” button causes air to flow from the face vent outlets.



When the “down arrow” button is pressed, air flows from the footwell outlets (front and rear).



If the “AUTO” button is pressed, the control module automatically selects the appropriate flap positions for the sensed conditions (temperature dependent). When cooling is required, air flows from the face vents. When heating is required, air flows from the footwells and the windshield defroster outlets.

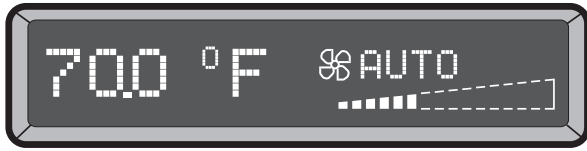

LCD Display: The E46 control panel/module has a backlit LCD display where the desired temperature and blower speed are shown. Display brightness varies according to ambient light levels when the headlamps and parking lamps are “off”. With the lamps “on”, brightness depends on dimming rheostat thumbwheel position.



Interior Temperature Sensor: As on all previous IHKA systems, an interior temperature sensor is located inside the control panel/module. Also as on previous systems, the sensor has its own electric fan to ensure adequate air flow over the sensor.



Temperature Selection Rocker Switch: The temperature selection rocker switch functions the same as those on E46 vehicles.



Blower Rocker Switch: Blower speed is selected using a rocker switch. Speed is increased by pressing the “+” end of the switch and decreased by pressing the “-” end.

When the system is at the lowest blower speed (speed “1”), pressing the “-” end turn the system “Off”.



Maximum Defrosting Button: This button function the same as the one on E38, except that the mixing flap is not affected (they are cable operated). When pressed:

- the fresh air flaps are opened
- the recirc. flaps are closed
- the windshield defrost flaps are opened
- all other distribution flaps are closed
- the blower runs at maximum speed
- the rear window defroster switches on

The A/C compressor does not turn on automatically, but will run if the “snowflake”: button is pressed.



A/C Compressor “snowflake” Button: Pressing the “snowflake” button causes the control panel/module to signal the engine control module (ECM) that A/C compressor operation is desired.

The ECM then energizes a relay to run the compressor.



Recirculating Air Button: This button controls air intake location as on previously covered IHKA systems.

On IHKA E46, though, recirculating air mode has no time limit. Once activated, it continues until the button is pressed again. However, the set position of recirc is saved for 15 minutes after ignition has been switched off (except for hot country settings). In this case recirc must be reselected.

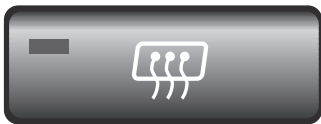

Rear Window Defroster Button: Pressing the rear window defroster button activates the rear window heating for about 17 minutes (depending on coding). Pressing the button again will activate the time cycle operation of 40 seconds on / 80 seconds off for 5 minutes



**INTERIOR
TEMPERATURE
SENSOR FAN**



IHKA E46 CONTROL PANEL/MODULE FUNCTIONS

The control panel/module handles all the functions necessary to operate the IHKA system:

- Blower speed
- Auxiliary cooling fan
- Air intake flaps (fresh/recirculating)
- Air distribution flaps (face vent, footwell, defroster)
- Heater core temperatures
- Evaporator temperature
- Special programmed functions
- Rear window defrost timing

And, like the E38 control panel/module, the E46 version has an EEPROM for fault code storage. The module can go into “sleep mode” to reduce power consumption when the ignition is switched “off,” but still retain control panel settings and fault code information.

***NOTE:** If the control module is replaced it must be coded.

SUBSTITUTE VALUE OPERATION

If an input potentiometer or sensor (or its circuit) fails, the control panel/module will ignore the faulty input and, in its place, use a replacement value which has been programmed into its memory for just this purpose. The replacement value, typically a mid-scale value for a

Data on working range and substitute value in event of cutout or K bus fault.

Temperature sensor	Working range	Substitute value
Heat exchange sensor	5 °C ... 124 °C	55 °C
Evaporator sensor	-10 °C ... 30 °C	0 °C
Interior temperature sensor	10 °C ... 40 °C	20 °C
Exterior temperature value	K-bus	0 °C
Coolant temperature value	K-bus	100 °C
Specified temperature	16 °C ... 32 °C	22 °C

Data on resistance values at an ambient temperature of 25 °C and fault limits.

Temperature sensor	Resistance	Fault limit
Heat exchange sensor	9 kohms +/- 2%	Temperature > 125 °C
Evaporator sensor	9 kohms +/- 2%	Temperature > 120 °C
Interior temperature	10 kohms +/- 2%	Temperature > 89 °C or temperature =< -46 °C

particular input, allows the system to operate as normally as possible, despite the fault. The substitute value for the evaporator temperature sensor is significantly below the A/C compressor cycling point (0°C). Therefore, if the evaporator temperature sensor signal is not plausible, the substitute value will switch the refrigeration system off.

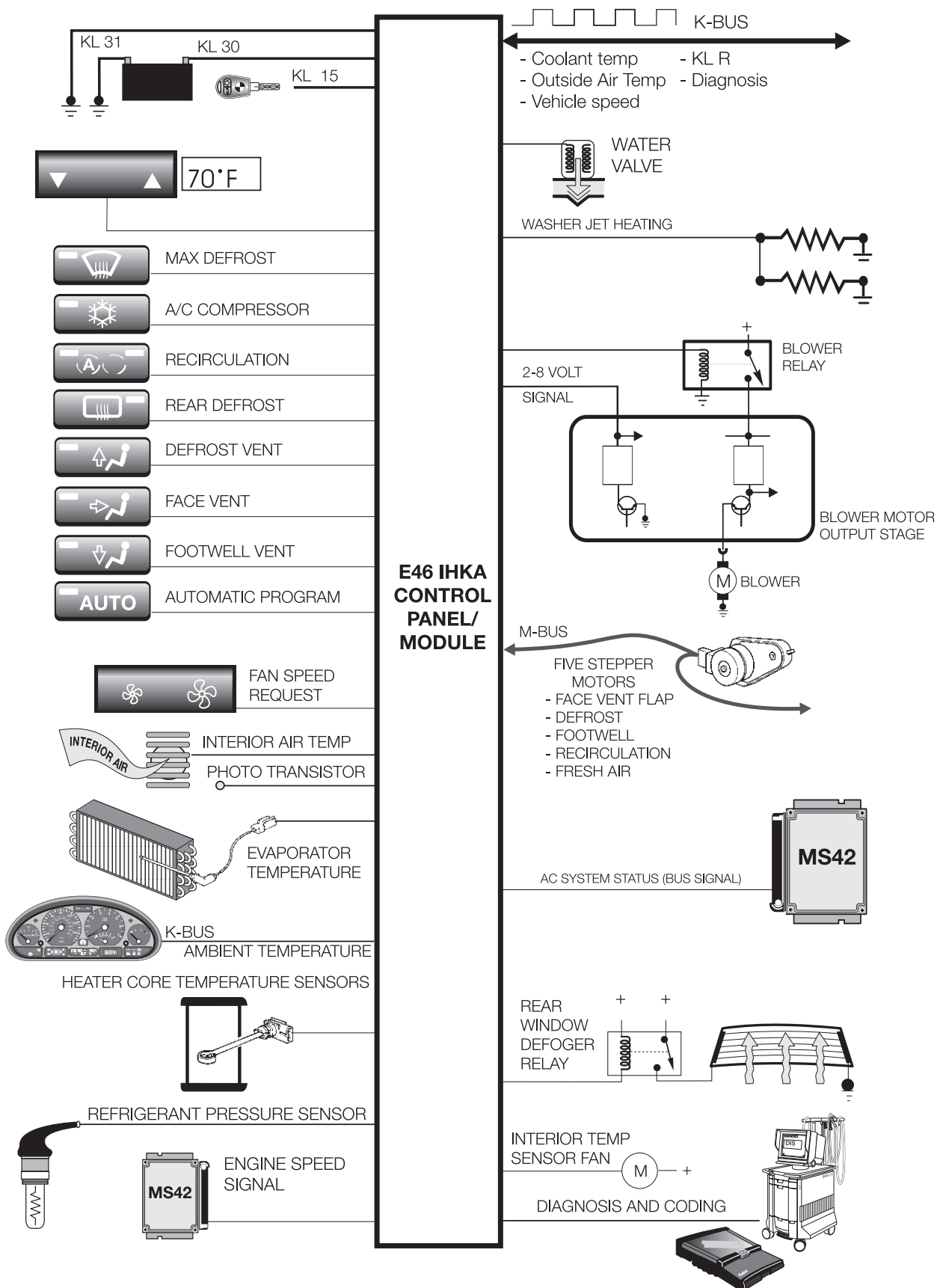

FRESH AIR MICROFILTER

The active carbon fresh air micro filter is installed in the fresh air inlet of the engine compartment. The filter can be serviced quickly by removing the plastic cover and removing the filter.



IHKA E46 AIR INTAKE

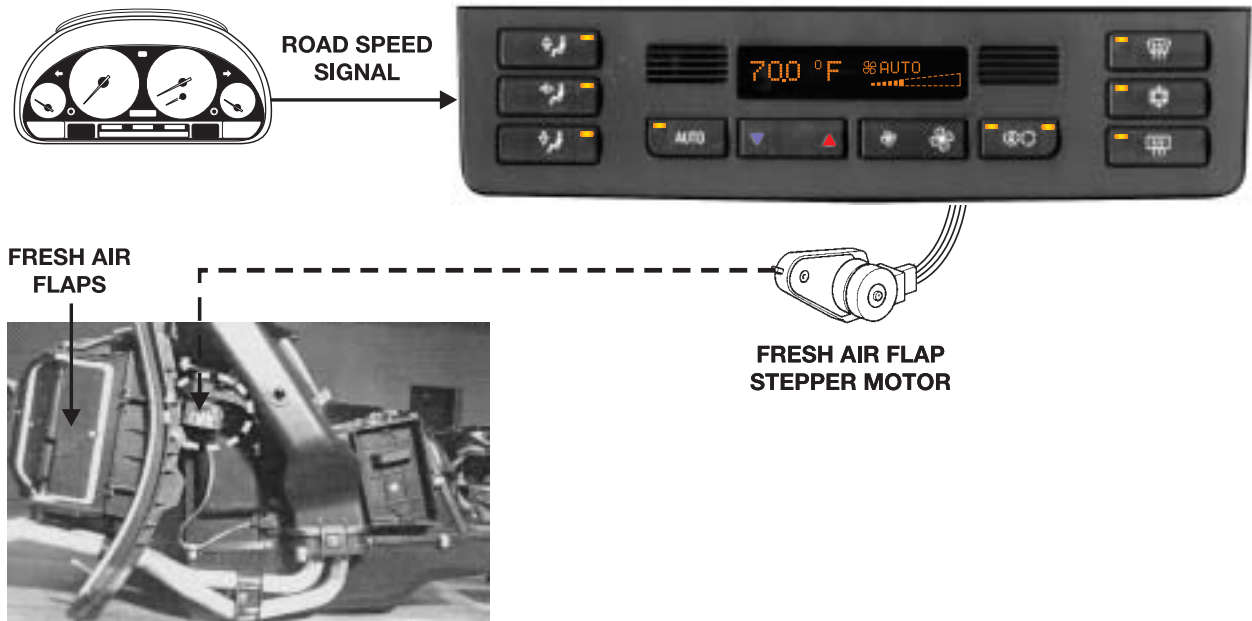

The fresh air flaps stepper motor operates only when the ignition switch is in “Run”. At engine shut-down, the fresh air flaps stay in their “last-used” position. When the ignition switch is again turned to “Run”, the control module/panel operates the stepper motor to move the flaps, if necessary.

When open, the flaps are positioned according to road speed; the flaps close incrementally with change in the road speed (to prevent the flaps from continually opening and closing due to slight changes in speed). At 100 mph the fresh air flaps are only 20% to 40% open (depending on blower speed).

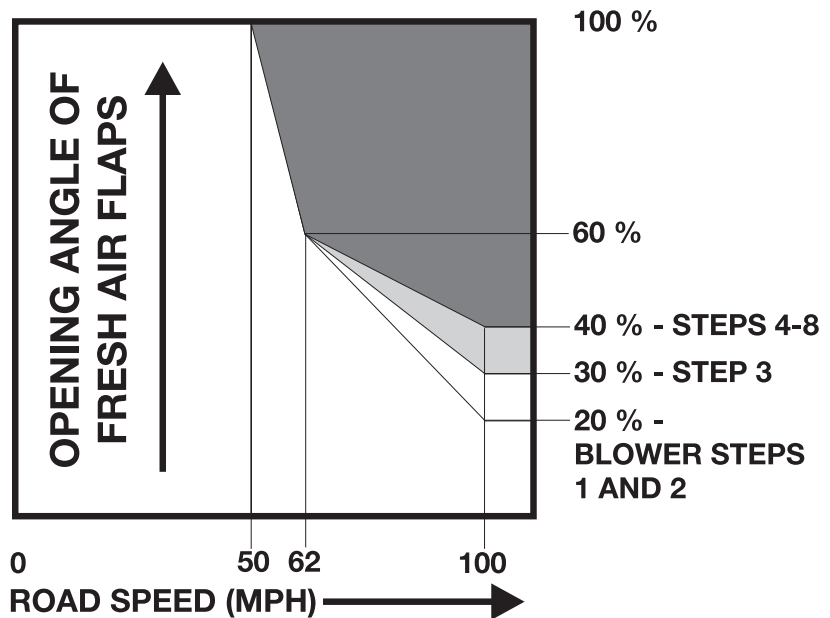

IHKA E46 BLOWER CONTROL

The E46 offers eight discrete speeds.

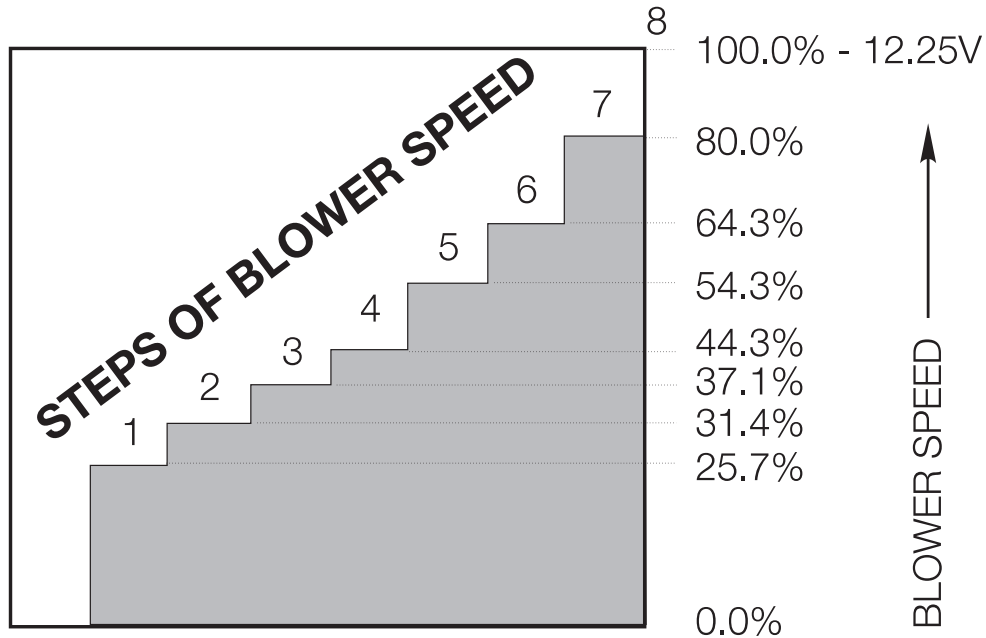

The control panel/module processes the blower speed rocker switch input and sends a signal to the final stage unit. The final stage unit then regulates blower motor voltage to control blower speed, the “Y factor” can also influence blower speed in the “AUTO” program.



The blower rocker is the master controller for the IHKA system as it can be used to switch the system “Off”. This is done by lowering blower speed to the lowest speed and then pressing the decrease (smaller fan) side of the button one more time:

- The blower motor turns off **and**
- **All** flaps are closed **and**
- All function LEDs and the LCD display are switched off **and**
- The rear window defroster is switched off **and**
- The A/C compressor is switched off

The interior temperature sensor blower continues to operate, though, and the control panel/module pulses the appropriate water valve if either left or right desired temperature is above the sensed interior temperature.

The IHKA E46 system can be turned “on” again by pressing any button on the control panel/module face.

IHKA E46 BLOWER CONTROL

IHKA E46 blower control is most similar to that of IHKA E36 since a separate final stage unit is mounted on the housing assembly (passenger's side).

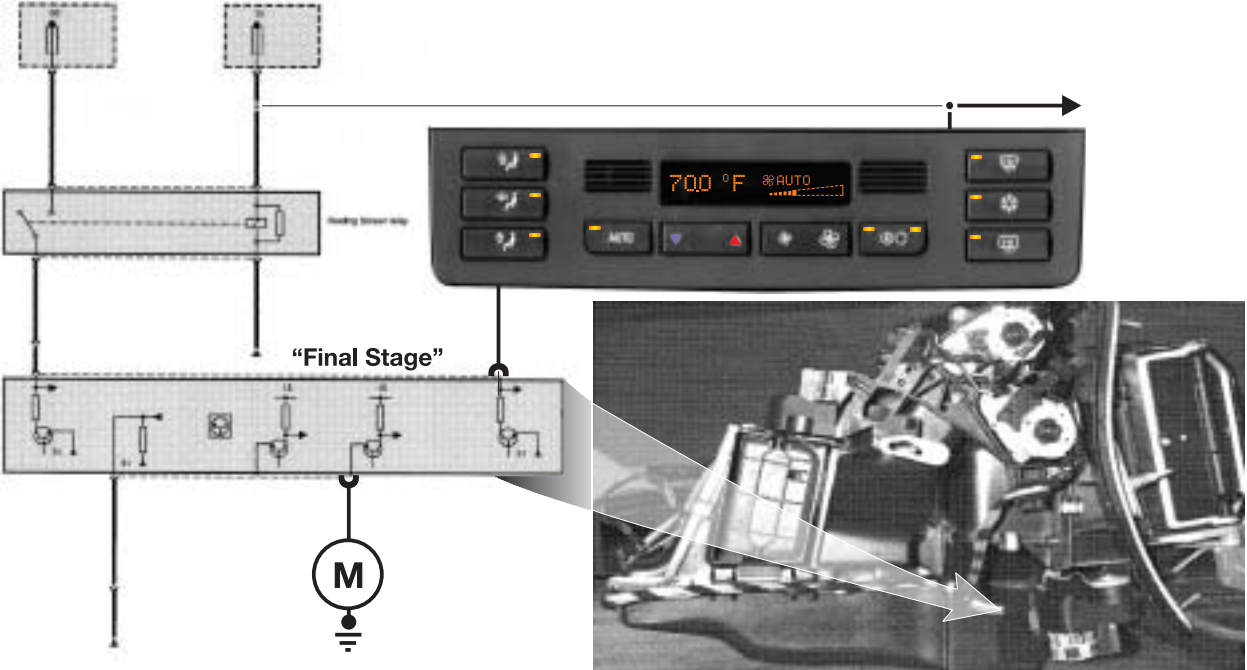

STEPPER MOTOR M-BUS CONTROL

The E46 continues to use the M-Bus for stepper motor control. All five stepper motors of the IHKA are now bus controlled including:

- Two fresh air/recirc-air flap motors
- Face vent flap motor
- Footwell flap motor
- Defrost flap motor

Due to the requirement for a fast acting motor for the fresh/recirc flaps, two different stepper motors (slow/fast) are used in the system.

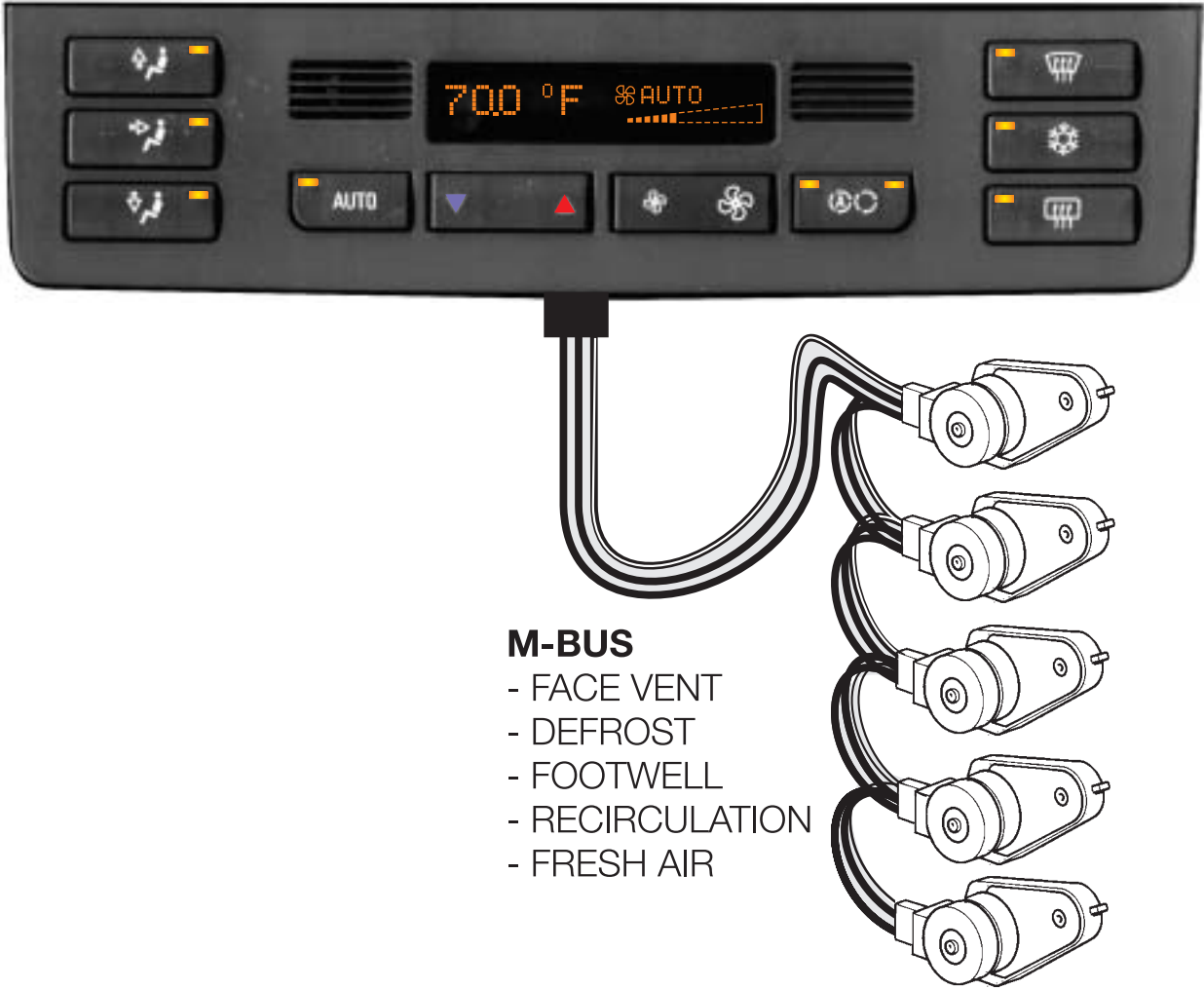

TEMPERATURE REGULATION-HEATING

The E46 uses one water valve/heater core as part of interior temperature regulation. The water valve is pulsed to control the flow of coolant through the heater core as on other systems.

Temperature regulation is based on the inputs from:

- Temperature control switch
- Interior temperature sensor
- Ambient temperature signal (from instrument cluster via K-Bus)
- Heater core sensor
- Evaporator temperature signal
- "Y" factor

The rocker switch is used to select the desired interior temperature which is displayed in the matrix of the control panel. The range for temperature display is from 60 to 90 ° F.

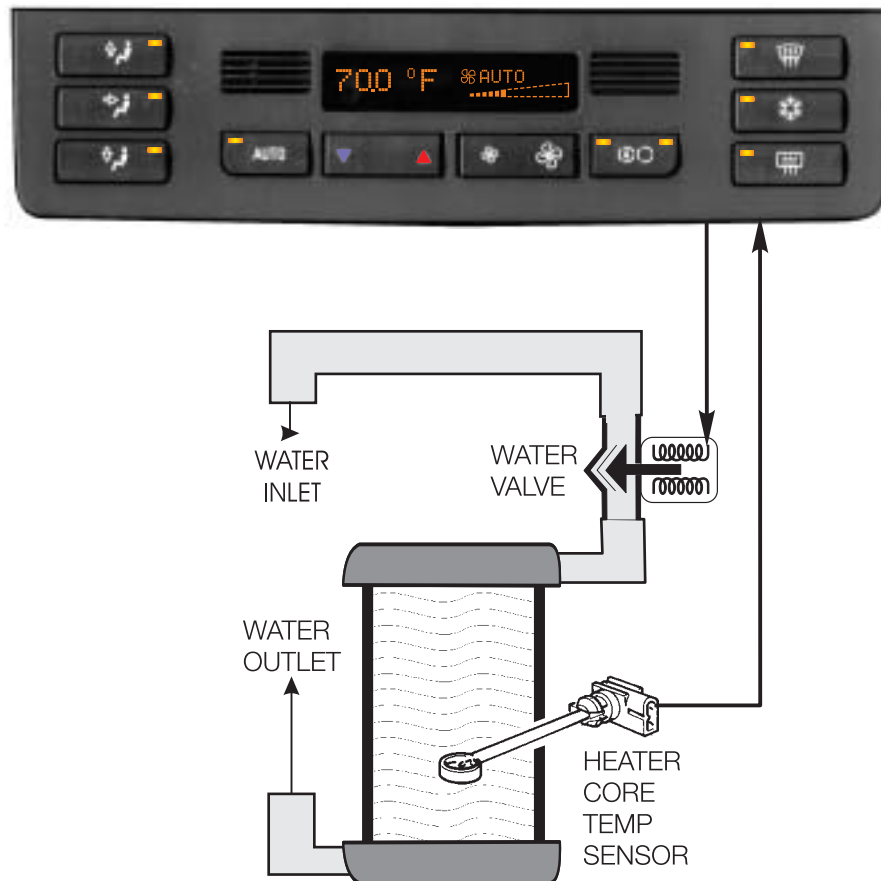

SERVICE STATION FEATURE - The "Service Station" feature introduced with the E38 IHKA is now integrated into the E46 IHKA. This prevents the heater core from being flooded with hot coolant when refueling the vehicle.

IHKA E46 TEMPERATURE MIXING

The temperature mixing flap is mechanically actuated, using the thumbwheel in the center face vent outlet

Any time the face vents are open, rotating the thumbwheel will operate the mixing flap which is located above the space between the evaporator and the heater cores. Opening the mixing flap allows more cooled air to enter the face vent ductwork. Closing the flap increases the proportion of heated air which enters the face vent ductwork.

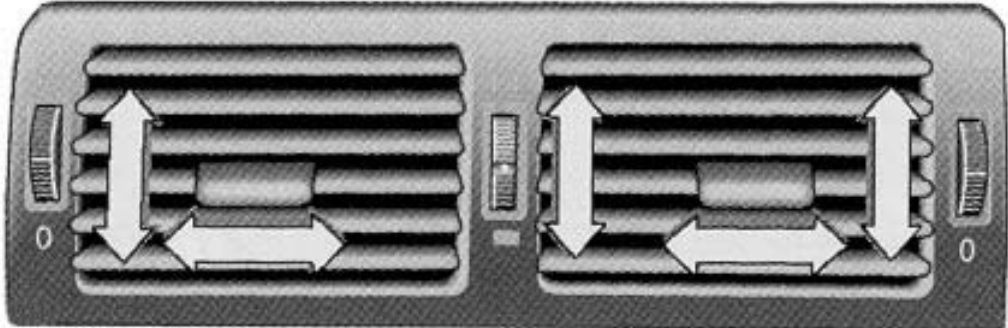

**STRATIFIED AIR OUT OF
FACE VENT OUTLETS**

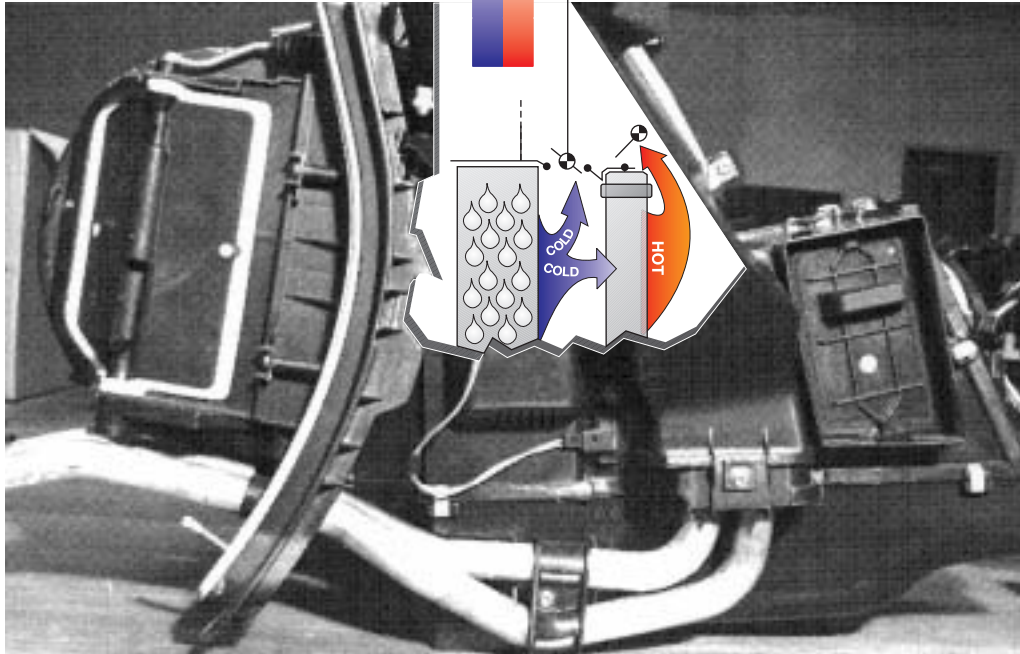

TEMPERATURE REGULATION COOLING

Air conditioning control on the E46 is similar to the E39 IHKA system. The system uses the variable displacement compressor introduced on the E39. The swash plate of the compressor is hinged so that it can vary the piston travel based on the output requirements of the system.

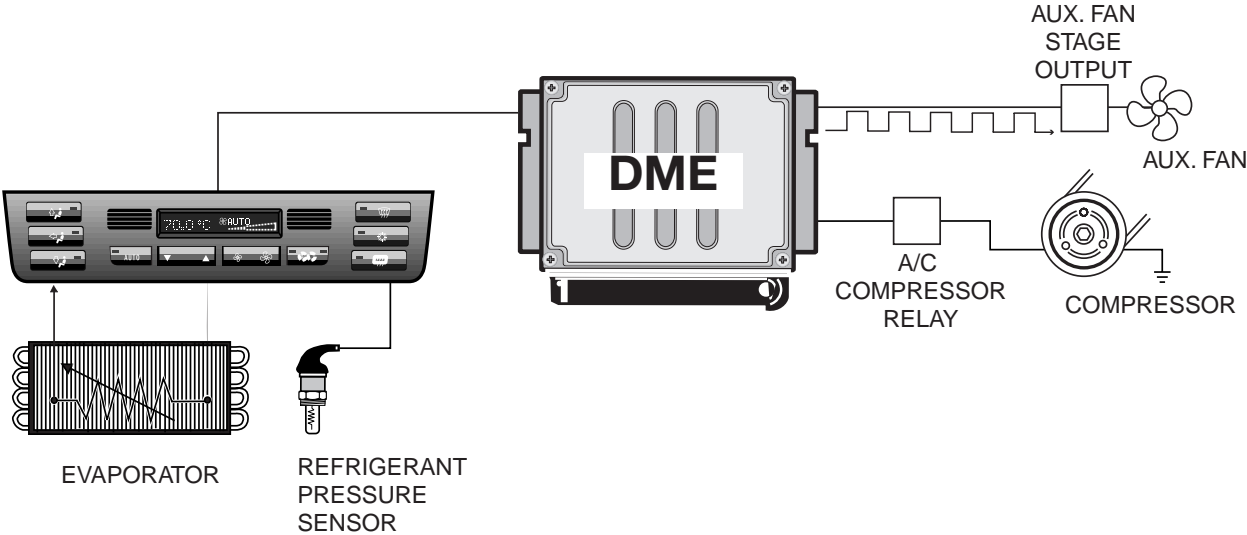
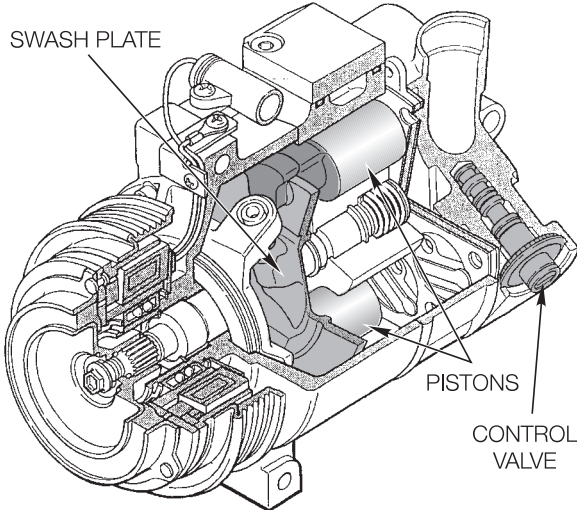

COMPRESSOR CONTROL

Control of the A/C compressor is a function of the MS42.0 engine control module which also regulates auxiliary fan operation.

Pressing the snowflake button is a request for A/C activation. As long as the evaporator temperature is above 36°F, the IHKA will signal the MS42.0 control module to activate the compressor.

The IHKA control module sends the following signals to the MS42.0 over the K-Bus and CAN Bus via the instrument cluster:

- Request for A/C activation (signal KO)
- Load torque for switching the compressor on
- Requested auxiliary fan speed

The IHKA determines the load torque for compressor activation and required auxiliary fan speed from the pressure sensor mounted on the receiver/dryer.

The refrigerant pressure sensor provides a linear voltage input signal (0-5 volts) to the IHKA control module. The IHKA processes this signal and determines the load torque of the system (0 to 30 Nm with a variable displacement compressor). The higher the pressure in the system, the higher the voltage input signal to the IHKA. The pressure sensor inputs to IHKA too high or too low will cause the compressor to be deactivated.

The output signal to the MS42.0 will enable the engine control module to modify the idle speed, timing and fuel injection amount based on the load that will be imposed when the compressor is activated.

For full engine load situations, the compressor activation is “cut out”. The cut out time is for 4-10 seconds when the full throttle signal is present and vehicle speed is less than 10 mph.

AUXILIARY FAN CONTROL

The Auxiliary Fan motor incorporates an output final stage that activates the fan motor at variable speeds.

The auxiliary fan is controlled by ECM. The motor output stage receives power and ground and activates the motor based on a PWM signal (10-100 Hz) received from the ME 7.2.

The fan is activated based on the following factors:

- Radiator outlet temperature sensor input exceeds a preset temperature.
- IHKA signalling via the K and CAN bus based on calculated refrigerant pressures.
- Vehicle speed
- Battery voltage level

When the over temperature light in the instrument cluster is on (120°C) the fan is run in the overrun function. This signal is provided to the ECM via the CAN bus. When this occurs the fan is run at a frequency of 10 Hz.

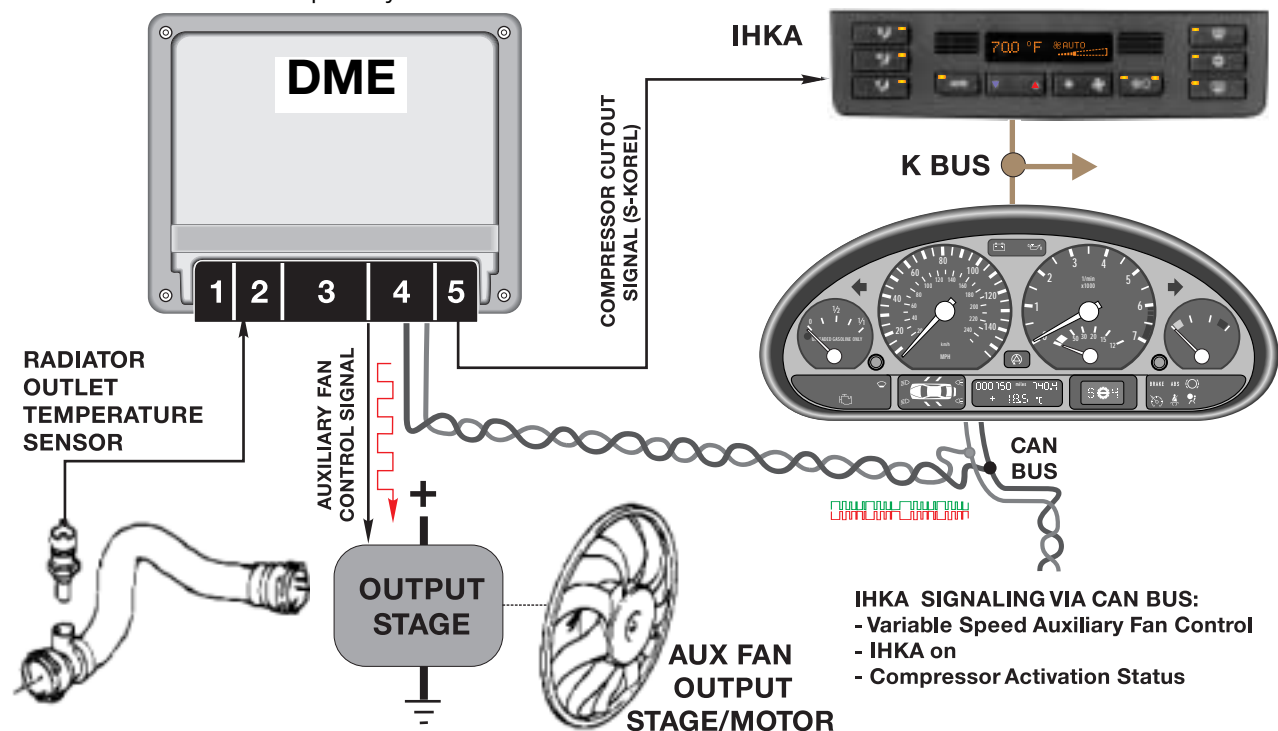
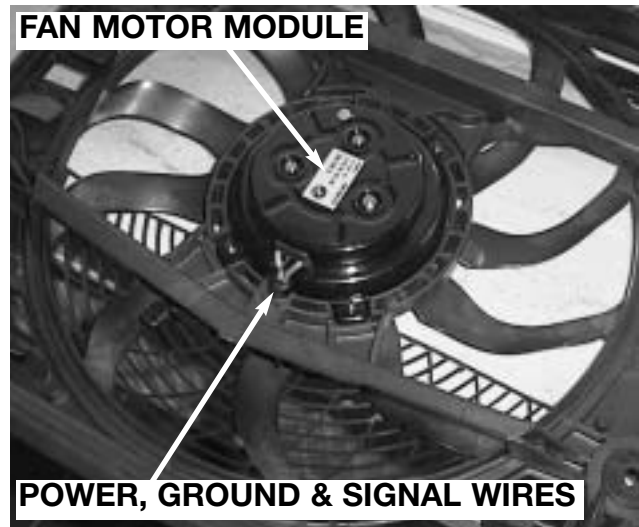

The pressure sensor receives a 5 volt power supply from the IHKA control unit. The sensor signal is evaluated and forwarded to the DME via the K-Bus. In the process, the refrigerant pressure in the air-conditioning circuit is converted to a load torque and calculation for the required fan speed (stage)

Refrigerant pressure-fan stage conversion table

Each fan stage that is determined is transmitted from the ECM to the auxiliary fan output stage. Prerequisite is a speed less than 50 mph.

Pressure in bar	Fan stage
8	0
9	1
11	2
13	3
14	4
15	5
16	6
17	7
18	8
19	9
20	10
21	11
22	12
23	13
24	14
> 24	15

SYSTEM OPERATION

The balance of the E46 IHKA system's features and operation carry over from the E36 including:

- Stepper motor calibration run
- Cold start interlock

DIAGNOSIS TROUBLESHOOTING

The "self diagnostics" of the IHKA control module monitors the status of inputs and outputs of the system. If a fault is detected, it is initially entered in RAM and then in the EEPROM when the ignition is switched off. If available, a replacement value will be activated when various sensor faults are detected as with previous systems. A maximum of six faults can be stored in the EEPROM when the ignition is switched off.

The E46 IHKA is connected to the diagnostic link via the K-Bus/instrument cluster. The system uses the E46 "Fault Symptom Troubleshooting" procedures for troubleshooting problems and faults with the system.

When troubleshooting problems with the E46 IHKA, it is important to note that because the Car/Key Memory feature can change the functionality of the system, a review of the setting should be performed prior to condemning a component as faulty.

IHKA PERSONALIZATION

The features of Car/Key Memory allow various functions/features of the IHKA control to be tailored to the individual owner's/driver's wishes.

The functions of the IHKA that can be programmed to the owner's/driver's wishes include:

- Automatic activation of recirc when the vehicle is started
- Adjustment (raising/lowering) of the blower speed
- Automatic opening of the ventilation flaps with warm coolant
- Automatic closing of the footwell flap with A/C activation
- Automatic closing of the defroster flaps with A/C activation
- Correction of the set temperature (raise/lower)
- Automatic activation of the compressor control when the ignition is switched on
- Auto program for the blower control when the ignition is switched on

These features are programmed using the coding/programming function of the DIS/MoDiC.

